

GUIDE

Aluminum/Stainless MATERIALS CATALOG

アルミ・ステンレス材料カタログ

Aluminum/Stainless
MATERIALS CATALOG

アルミ形材

アルミ 等辺アングル	4P
アルミ 不等辺アングル	4P
アルミ 等辺角パイプ	5P
アルミ 不等辺角パイプ	5P
アルミ 丸パイプ	7P
アルミ チャンネル	7P
アルミ フラットバー	9P
アルミ T型バー	9P
アルミ Z型バー	9P
アルミ C型チャンネル	9P
アルミ H型バー	9P

ステンレス材

ステンレス 等辺角パイプ	10P
ステンレス 不等辺角パイプ	11P
ステンレス 丸パイプ	12P
ステンレス フラットバー	13P
ステンレス 等辺アングル	13P

カーペット押え	14P
---------	-----

ノンスリップ

アルミ	16P
ステンレス	17P

等辺アングル

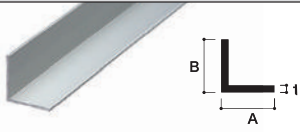

$t \times A \times B$

不等辺アングル

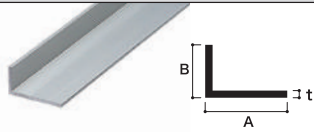

$t \times A \times B$

等边角パイプ



$t \times A \times B$

不等边角パイプ



$t \times A \times B$

丸パイプ



$t \times A$

チャンネル



$t \times A \times B$

フラットバー



$t \times A$

T型バー

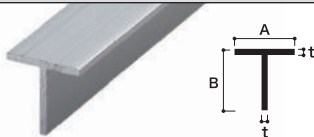

$t \times A \times B$

Z型バー

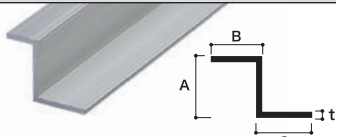

$t \times A \times B \times C$

C型チャンネル

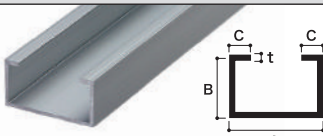

$t \times A \times B \times C$

H型バー

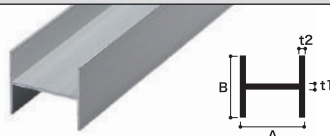

$t1 \times t2 \times A \times B$

カーペット押え



※形状例 S-2512

ノンスリップ

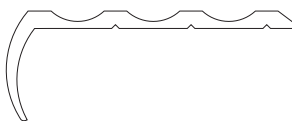

※形状例 A-38

ノンスリップ

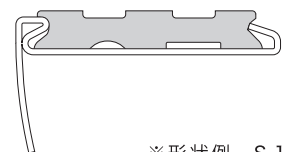

※形状例 S-135

アルミ形材

アルミ形材

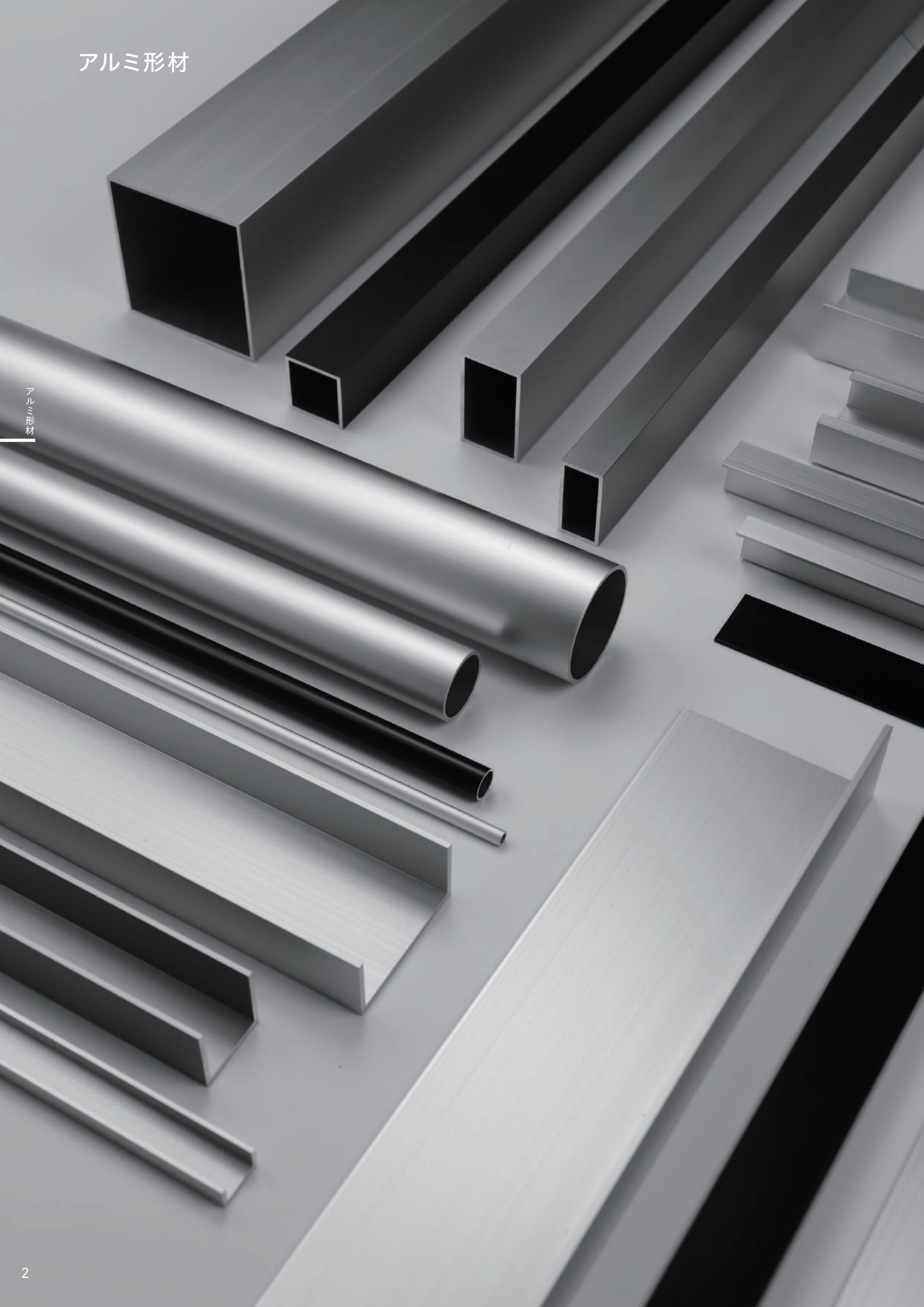

Color Variation

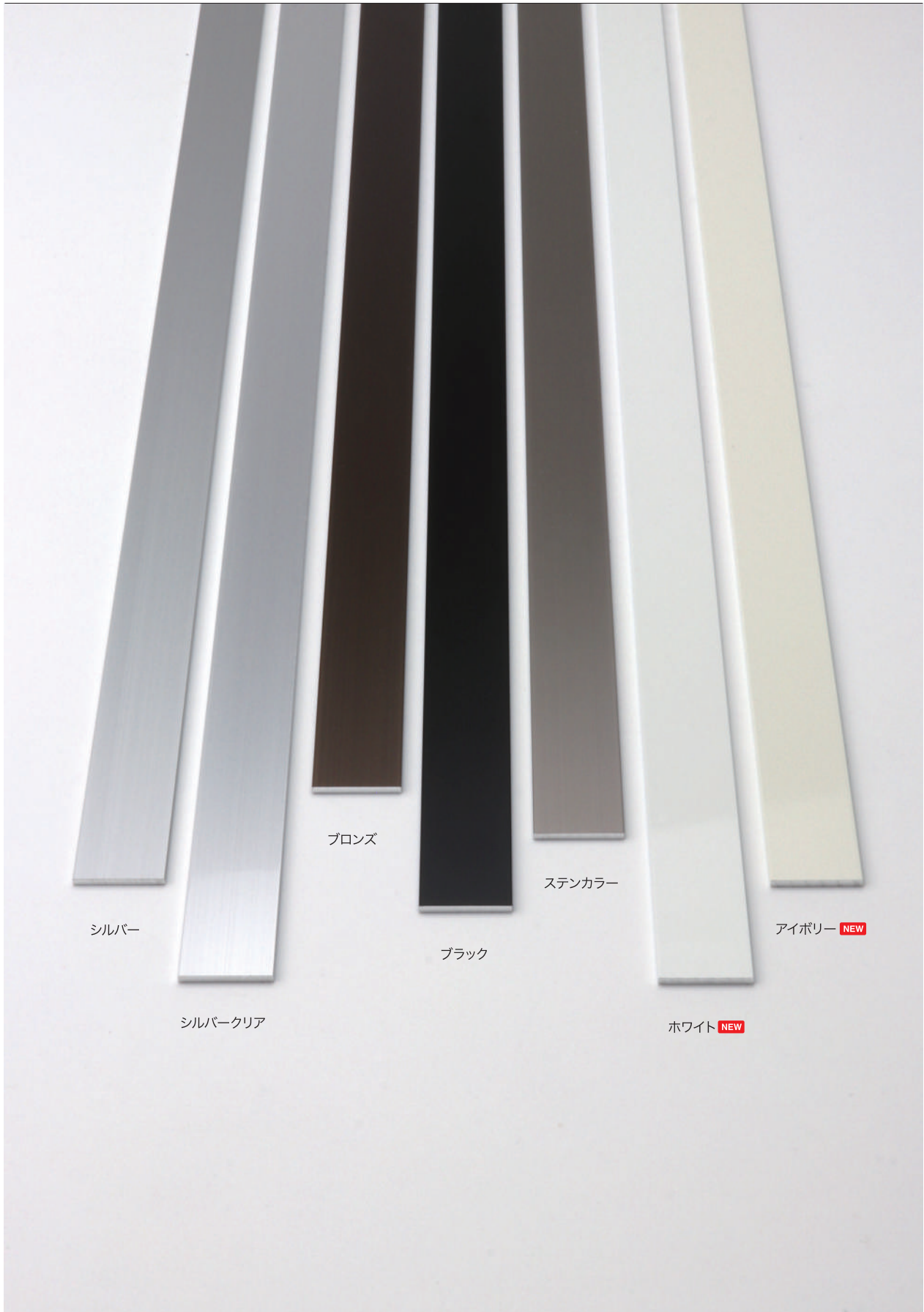

アルミ型材

A6063S-T5 オプション▶ ■ロット販売(当社オリジナル抗菌アルマイト仕様・別注カラー) ■切断 ■穴明 ■塗装 ■各種加工

アルミ 等辺アングル

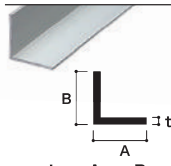

t × A × B	シルバー	シルバー クリア	ブロンズ	ブラック	ステン カラー	ホワイト NEW	アイボリー NEW
	B2 アルマイト	クリア 艶有	クリア 艶消	クリア 艶消	クリア 艶消	クリア 艶有	クリア 艶有
L=4000							
1.2 × 10 × 10	●		●	●	●	●	●
1.2 × 12 × 12	●		●	●	●		
1.2 × 13 × 13	●						
1.5 × 15 × 15	●	●	●	●	●	●	●
2.0 × 15 × 15	●		●				
3.0 × 15 × 15	●						
1.5 × 19 × 19	●						
1.5 × 20 × 20	●	●					
2.0 × 20 × 20	●	●	●	●	●	●	●
3.0 × 20 × 20	●						
1.2 × 25 × 25	●						
1.5 × 25 × 25	●						
2.0 × 25 × 25	●	●	●	●	●	●	●
2.5 × 25 × 25	●						
3.0 × 25 × 25	●						
4.0 × 25 × 25	●						
1.2 × 30 × 30	●						
1.5 × 30 × 30	●	●					
2.0 × 30 × 30	●	●	●	●	●	●	●
3.0 × 30 × 30	●	●	●	●	●		
5.0 × 30 × 30	●						
2.0 × 35 × 35	●						
3.0 × 35 × 35	●						
1.5 × 38 × 38	●						
2.0 × 40 × 40	●	●	●		●	●	●
3.0 × 40 × 40	●	●	●	●	●		
4.0 × 40 × 40	●						
5.0 × 40 × 40	●						
1.5 × 45 × 45	●						
1.5 × 50 × 50	●		●				
2.0 × 50 × 50	●						
3.0 × 50 × 50	●	●	●	●	●	●	●
4.0 × 50 × 50	●						
5.0 × 50 × 50	●						
2.0 × 55 × 55	●						
2.0 × 60 × 60	●						
5.0 × 60 × 60	●						
2.2 × 70 × 70	●						
5.0 × 75 × 75	●						
2.3 × 80 × 80	●						

●寸法は全てmm単位です。

アルミ 不等辺アングル

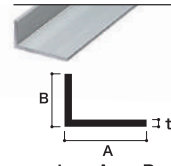

t × A × B	シルバー	シルバー クリア	ブロンズ	ブラック	ステン カラー	ホワイト NEW	アイボリー NEW
	B2 アルマイト	クリア 艶有	クリア 艶消	クリア 艶消	クリア 艶消	クリア 艶有	クリア 艶有
L=4000							
1.2 × 15 × 6	●		●	●			
1.5 × 20 × 9	●						
1.5 × 25 × 9	●						
1.5 × 30 × 9	●						
1.5 × 40 × 9	●						
1.5 × 15 × 10	●						
1.9 × 15 × 10	●						
2.0 × 15 × 10	●						
1.5 × 20 × 10	●		●	●	●		
1.5 × 25 × 10	●		●				
1.5 × 30 × 10	●		●	●	●		
1.5 × 40 × 10	●						
2.0 × 50 × 10	●		●				
2.5 × 35 × 13	●						
1.8 × 18 × 15	●						
1.5 × 20 × 15	●	●	●	●			
1.8 × 20 × 15	●						
2.0 × 20 × 15	●	●	●		●	●	●
1.5 × 25 × 15	●						
1.8 × 25 × 15	●						
2.0 × 25 × 15	●		●			●	●
1.5 × 30 × 15	●						
2.0 × 30 × 15	●		●	●	●	●	●
3.0 × 30 × 15	●						
2.0 × 35 × 15	●						
2.0 × 40 × 15	●						
1.5 × 45 × 15	●						
1.5 × 63.5 × 19	●						
2.0 × 25 × 20	●						
2.0 × 30 × 20	●	●	●		●		
3.0 × 30 × 20	●						
2.0 × 40 × 20	●	●	●	●	●	●	●
3.0 × 40 × 20	●	●					
2.0 × 50 × 20	●						
3.0 × 50 × 20	●						
3.0 × 30 × 25	●						
2.0 × 50 × 25	●					●	●
3.0 × 50 × 25	●	●	●				
1.5 × 76.2 × 25.4	●						
4.0 × 50 × 35	●						
3.0 × 80 × 40	●					●	●
5.0 × 75 × 50	●						

●寸法は全てmm単位です。

アルミ 等辺角パイプ

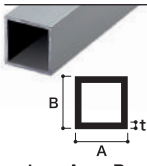

t × A × B	シルバー		シルバー クリアー	ブロンズ	ブラック	ステン カラー	ホワイト NEW	アイボリー NEW	キャップ	
	B2 アルマイト		クリア 艶有	クリア 艶消	クリア 艶消	クリア 艶消	クリア 艶有	クリア 艶有	樹脂	アルミ
	L=4000	5000	5000	4000						
1.0 × 10 × 10	●	●		●		●				○
1.2 × 12 × 12	●	●		●		●				○
1.5 × 15 × 15	●	●		●		●	●	●		○
1.5 × 19 × 19	●									
1.5 × 20 × 20	●	●								
2.0 × 20 × 20	●	●		●	●		●	●		○
1.5 × 25 × 25	●	●								
2.0 × 25 × 25	●	●		●		●	●	●		○
1.5 × 30 × 30	●	●		●						
2.0 × 30 × 30	●	●		●	●		●	●		○
2.0 × 35 × 35	●	●								
2.0 × 40 × 40	●	●	●	●		●	●	●		○
2.0 × 50 × 50	●	●	●	●	●	●	●	●		○
3.0 × 50 × 50	●									
2.0 × 60 × 60	●	●								○
2.0 × 70 × 70	●	●								
2.5 × 70 × 70	●									
2.0 × 75 × 75	●	●				●	●	●		○
2.5 × 75 × 75	●									
2.5 × 80 × 80	●									
3.0 × 100 × 100		●								○

●寸法は全てmm単位です。

アルミ 不等辺角パイプ

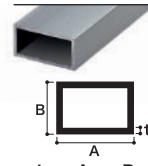

t × A × B	シルバー		シルバー クリアー	ブロンズ	ブラック	ステン カラー	ホワイト NEW	アイボリー NEW	キャップ	
	B2 アルマイト		クリア 艶有	クリア 艶消	クリア 艶消	クリア 艶消	クリア 艶有	クリア 艶有	樹脂	アルミ
	L=4000	5000	5000	4000						
1.2 × 15 × 10	●						●			
1.5 × 15 × 10	●			●						
1.5 × 20 × 10	●									
1.5 × 30 × 10	●	●					●			
2.0 × 40 × 10	●	●								
1.2 × 18 × 12	●									
1.5 × 20 × 15	●	●		●						
2.0 × 20 × 15	●	●								
1.5 × 25 × 15	●	●		●						
1.5 × 30 × 15	●	●		●	●	●	●	●		○
2.0 × 25 × 20	●	●		●						
1.5 × 30 × 20		●								
2.0 × 30 × 20	●	●		●						○
2.5 × 30 × 20		●								
1.5 × 40 × 20			●							
2.0 × 40 × 20	●	●		●	●	●	●	●		○
1.3 × 30 × 25	●									
2.0 × 40 × 25	●	●								
2.0 × 50 × 25	●	●		●		●	●	●		○
2.0 × 60 × 25	●	●								
2.0 × 40 × 30	●	●					●			
2.0 × 50 × 30	●	●								○
2.0 × 60 × 30	●	●	●	●	●	●	●	●		○
2.0 × 70 × 30	●	●		●						○
2.0 × 60 × 40	●	●		●						
2.0 × 80 × 40	●	●		●			●	●		○
2.5 × 80 × 40	●	●								
2.0 × 70 × 50	●	●								○
2.0 × 100 × 30		●								
2.5 × 100 × 30	●	●								
2.0 × 100 × 50		●		●			●	●		○
2.5 × 100 × 50	●	●								
3.0 × 100 × 50		●								

●寸法は全てmm単位です。

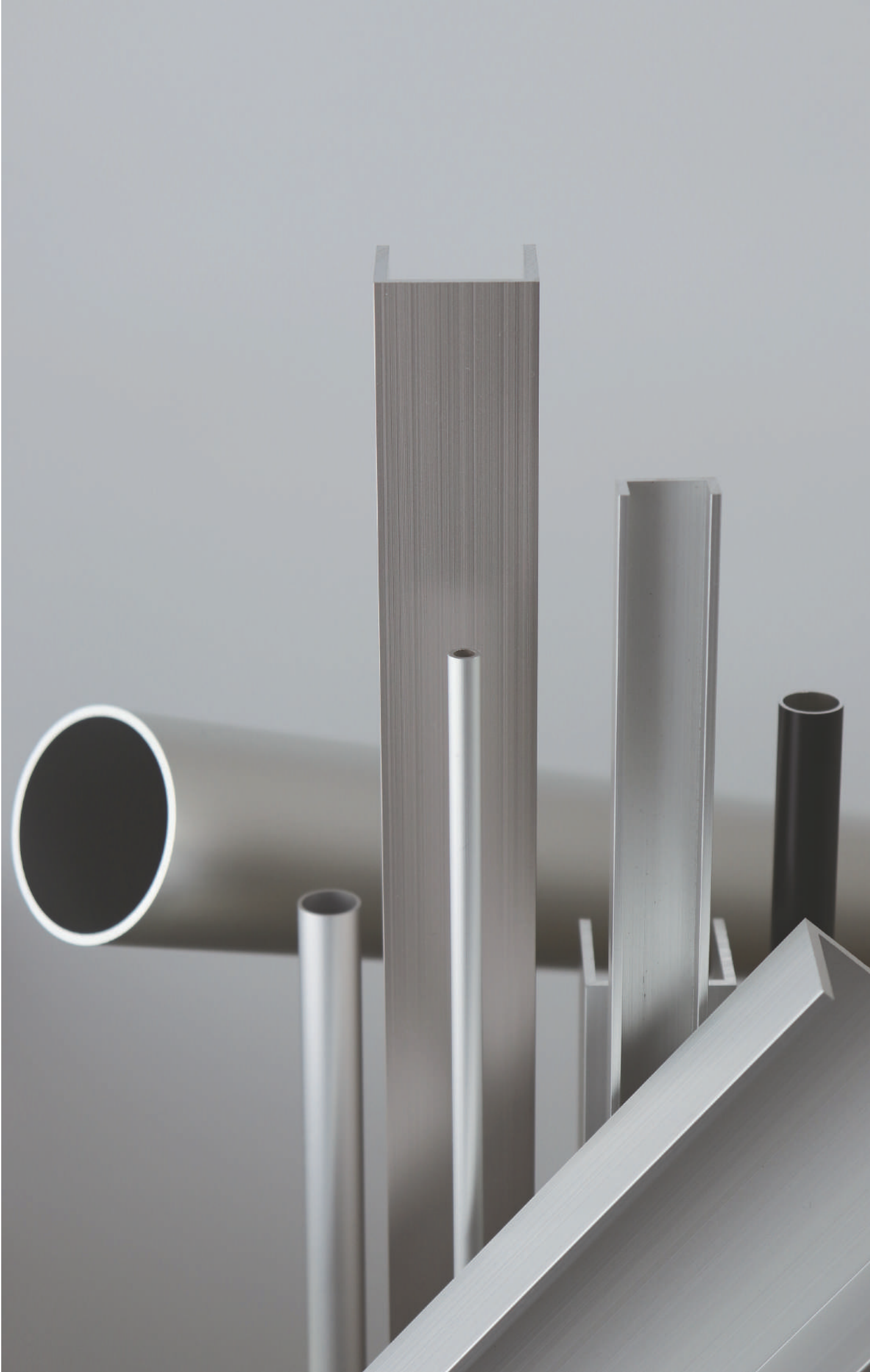

アルミ型材

A6063S-T5

オプション▶ ■ロット販売(当社オリジナル抗菌アルマイト仕様・別注カラー) ■切断 ■穴明 ■塗装 ■各種加工

アルミ 丸パイプ



t × A	シルバー	ブラック	キャップ
	B2 アルマイト	クリア 艶消	
	L=4000		樹脂
1.0 × 6	●		
1.0 × 9	●		○
1.0 × 10	●		
1.0 × 12	●		○
1.0 × 13	●	●	
1.0 × 15	●		○
1.0 × 16	●		
1.0 × 18	●		○
1.0 × 19	●		
2.0 × 20	●		
1.0 × 25	●		○
2.0 × 25	●		○
2.0 × 30	●		
1.5 × 32	●		○
2.0 × 32	●		○
1.5 × 38	●		
2.0 × 50	●		○

●寸法は全てmm単位です。

アルミ チャンネル



t × A × B	シルバー	シルバー クリアー	ブラック	ステン カラー
	B2 アルマイト	クリア 艶有	クリア 艶消	クリア 艶消
	L=4000			
1.0 × 5.5 × 8	●			
1.5 × 6.2 × 8.3	●			
1.0 × 6.5 × 9	●			
1.0 × 7 × 7	●			
1.0 × 7.5 × 10	●			
1.5 × 7.5 × 10	●			
1.0 × 7.5 × 25	●			
1.0 × 8.5 × 10	●			
1.0 × 10 × 10	●			
1.5 × 10 × 10		●		
1.6 × 10 × 10	●			
1.2 × 10 × 15	●			
1.0 × 11 × 5	●			
1.0 × 12 × 10	●			
2.0 × 12 × 12	●			
1.2 × 12.4 × 12.4	●			
1.0 × 14 × 10	●			
2.0 × 14 × 10	●			
2.0 × 15 × 15	●			
1.5 × 15 × 24	●			
2.0 × 18 × 10	●			
1.0 × 18 × 12	●			
2.0 × 20 × 12	●			
2.0 × 20 × 20	●			●
2.0 × 22 × 12	●			
1.0 × 22 × 13	●			
1.5 × 24 × 10	●			
2.0 × 25 × 15	●			
2.0 × 25 × 25	●			
1.0 × 27 × 15	●			
2.0 × 30 × 15	●		●	
2.4 × 30 × 20	●			
2.4 × 30 × 30	●			●
2.0 × 35 × 20	●			
2.4 × 35 × 20	●			
1.9 × 38 × 20	●			
2.0 × 40 × 20	●			
3.0 × 40 × 20	●			
2.0 × 40 × 30	●			
2.5 × 50 × 20	●			
2.5 × 50 × 25	●			
3.0 × 50 × 25	●			
3.0 × 60 × 30	●			
3.0 × 100 × 50	●			

●寸法は全てmm単位です。



アルミ型材

A6063S-T5

オプション▶

■ロット販売(当社オリジナル抗菌アルマイト仕様・別注カラー) ■切断 ■穴明 ■塗装 ■各種加工

アルミ フラットバー

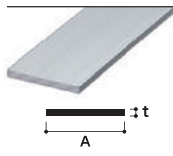

t × A	シルバー	シルバー クリア	ブロンズ	ブラック	ステン カラー	ホワイト NEW	アイボリー NEW
	B2 アルマイト	クリア 艶有	クリア 艶消	クリア 艶消	クリア 艶消	クリア 艶有	クリア 艶有
L=4000							
2.0 × 10	●		●				
3.0 × 10	●		●				
5.0 × 10	●						
3.0 × 12	●		●				
4.0 × 12	●						
2.0 × 15	●		●				
3.0 × 15	●		●				
4.0 × 15	●						
5.0 × 15	●						
6.0 × 15	●						
2.0 × 20	●		●	●	●	●	●
3.0 × 20	●	●	●	●	●		
4.0 × 20	●						
5.0 × 20	●						
2.0 × 25	●				●	●	●
3.0 × 25	●	●	●				
4.0 × 25	●						
5.0 × 25	●						
2.0 × 30	●		●	●			
3.0 × 30	●	●	●		●	●	●
4.0 × 30	●						
5.0 × 30	●		●				
2.0 × 35	●						
3.0 × 35	●						
2.0 × 40	●						
3.0 × 40	●	●	●	●	●	●	●
4.0 × 40	●						
5.0 × 40	●						
6.0 × 40	●						
1.5 × 50	●			●	●	●	●
2.0 × 50	●						
3.0 × 50	●	●	●		●	●	●
4.0 × 50	●						
5.0 × 50	●			●	●		
6.0 × 50	●						
3.0 × 60	●		●			●	●
5.0 × 60	●						
2.0 × 64	●						
2.0 × 67	●						
3.0 × 70	●					●	●
5.0 × 70	●						
6.0 × 75	●						
2.0 × 88	●						
3.0 × 100	●					●	●
5.0 × 100	●						
6.0 × 100	●						
3.0 × 112	●						

●寸法は全てmm単位です。

アルミ T型バー

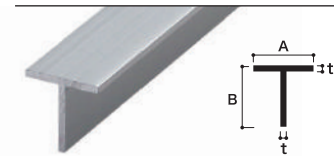

t × A × B	シルバー
L=4000	
1.0 × 15 × 16	●
1.2 × 15 × 16.2	●
1.6 × 17 × 11.5	●
2.0 × 20 × 20	●
3.0 × 23 × 25	●
2.0 × 40 × 30	●

●寸法は全てmm単位です。

アルミ Z型バー

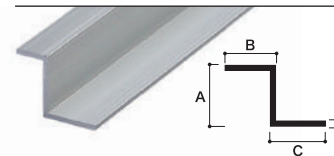

t × A × B × C	シルバー
L=4000	
1.0 × 10.5 × 11.5 × 11.5	●
2.0 × 23.5 × 12.5 × 21	●

●寸法は全てmm単位です。

アルミ C型チャンネル

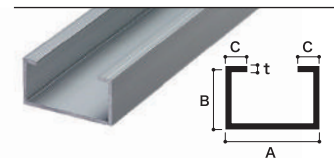

t × A × B × C	シルバー
L=4000	
1.5 × 33 × 18 × 6.5	●
2.0 × 44 × 22 × 7	●
3.0 × 70 × 23 × 10	●
3.0 × 100 × 25 × 20	●

●寸法は全てmm単位です。

アルミ H型バー

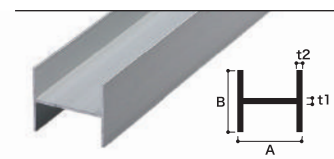

t1 × t2 × A × B	シルバー
L=4000	
1.5 × 1.2 × 34.4 × 30	●

●寸法は全てmm単位です。

ステンレス材

材質：SUS304 HL 仕上げ

ステンレス 等辺角パイプ

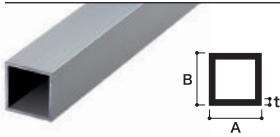

t × A × B	長さ	HL
1.0 × 7 × 7	4000	●
0.8 × 9 × 9	3000	●
0.8 × 9 × 9	4000	●
1.0 × 9 × 9	3000	●
1.0 × 9 × 9	4000	●
1.0 × 10 × 10	4000	●
1.2 × 10 × 10	4000	●
1.0 × 12 × 12	4000	●
1.2 × 12 × 12	4000	●
1.0 × 13 × 13	4000	●
1.2 × 13 × 13	4000	●
1.0 × 14 × 14	4000	●
1.2 × 14 × 14	4000	●
1.5 × 14 × 14	4000	●
1.0 × 16 × 16	5000	●
1.2 × 16 × 16	5000	●
1.5 × 16 × 16	5000	●
1.5 × 16 × 16	6000	●
1.0 × 19 × 19	5000	●
1.2 × 19 × 19	5000	●
1.5 × 19 × 19	5000	●
1.5 × 19 × 19	6000	●
2.0 × 19 × 19	5000	●
1.2 × 20 × 20	5000	●
1.5 × 20 × 20	5000	●
1.0 × 21 × 21	5000	●
1.2 × 21 × 21	5000	●
1.5 × 21 × 21	5000	●
1.2 × 22 × 22	5000	●
1.5 × 22 × 22	5000	●
1.2 × 24 × 24	5000	●
1.5 × 24 × 24	5000	●
1.2 × 25 × 25	5000	●
1.5 × 25 × 25	5000	●
1.5 × 25 × 25	6000	●
1.2 × 25.4 × 25.4	5000	●
1.5 × 25.4 × 25.4	5000	●
1.2 × 28.6 × 28.6	5000	●
1.5 × 28.6 × 28.6	5000	●
1.2 × 30 × 30	5000	●
1.5 × 30 × 30	5000	●
1.5 × 30 × 30	6000	●
2.0 × 30 × 30	5000	●
1.2 × 32 × 32	5000	●
1.5 × 32 × 32	5000	●

●寸法は全てmm単位です。

t × A × B	長さ	HL
1.5 × 32 × 32	6000	●
2.0 × 32 × 32	5000	●
1.2 × 35 × 35	5000	●
1.5 × 35 × 35	5000	●
1.2 × 38.5 × 38.5	5000	●
1.5 × 38.5 × 38.5	5000	●
2.0 × 38.5 × 38.5	5000	●
1.5 × 40 × 40	5000	●
1.5 × 40 × 40	6000	●
2.0 × 40 × 40	5000	●
1.2 × 41 × 41	5000	●
1.5 × 41 × 41	5000	●
1.5 × 41 × 41	6000	●
2.0 × 41 × 41	5000	●
1.5 × 46 × 46	5000	●
2.0 × 46 × 46	5000	●
1.5 × 50 × 50	5000	●
1.5 × 50 × 50	6000	●
2.0 × 50 × 50	5000	●
2.0 × 50 × 50	6000	●
3.0 × 50 × 50	5000	●
3.0 × 50 × 50	6000	●
1.5 × 60 × 60	5000	●
1.5 × 60 × 60	6000	●
2.0 × 60 × 60	5000	●
2.0 × 60 × 60	6000	●
3.0 × 60 × 60	5000	●
2.0 × 75 × 75	5000	●
2.0 × 75 × 75	6000	●
3.0 × 75 × 75	5000	●
2.0 × 100 × 100	5000	●
2.0 × 100 × 100	6000	●
3.0 × 100 × 100	5000	●

●寸法は全てmm単位です。

ステンレス 不等辺角パイプ

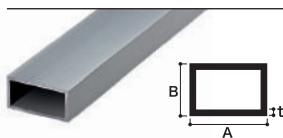

t × A × B	長さ	HL
1.0 × 19 × 10	4000	●
1.2 × 19 × 10	4000	●
1.0 × 22 × 12	5000	●
1.2 × 22 × 12	5000	●
1.5 × 22 × 12	5000	●
1.0 × 24 × 14	5000	●
1.2 × 24 × 14	5000	●
1.5 × 24 × 14	5000	●
2.0 × 24 × 14	5000	●
1.2 × 25 × 12	5000	●
1.5 × 25 × 12	5000	●
1.2 × 30 × 20	5000	●
1.2 × 30 × 25	5000	●
1.5 × 30 × 20	5000	●
1.5 × 30 × 25	5000	●
1.5 × 30 × 20	6000	●
1.0 × 32 × 16	5000	●
1.2 × 32 × 16	5000	●
1.5 × 32 × 16	5000	●
1.5 × 32 × 16	6000	●
1.0 × 40 × 18	5000	●
1.2 × 40 × 18	5000	●
1.2 × 40 × 20	5000	●
1.2 × 40 × 25	5000	●
1.5 × 40 × 18	5000	●
1.5 × 40 × 20	5000	●
1.5 × 40 × 25	5000	●
1.5 × 40 × 20	6000	●
1.5 × 40 × 25	6000	●
2.0 × 40 × 20	5000	●
2.0 × 40 × 25	5000	●
1.2 × 50 × 20	5000	●
1.5 × 50 × 20	5000	●
1.5 × 50 × 25	5000	●
1.5 × 50 × 30	5000	●
1.5 × 50 × 25	6000	●
1.5 × 50 × 30	6000	●
2.0 × 50 × 20	5000	●
2.0 × 50 × 25	5000	●
2.0 × 50 × 30	5000	●
1.2 × 51 × 26	5000	●
1.5 × 51 × 26	5000	●
1.5 × 51 × 26	6000	●
2.0 × 51 × 26	5000	●
1.5 × 60 × 25	5000	●
1.5 × 60 × 30	5000	●
1.5 × 60 × 40	5000	●

●寸法は全てmm単位です。

t × A × B	長さ	HL
1.5 × 60 × 30	6000	●
2.0 × 60 × 25	5000	●
2.0 × 60 × 30	5000	●
2.0 × 60 × 40	5000	●
2.0 × 60 × 30	6000	●
1.5 × 61 × 32	5000	●
1.5 × 61 × 32	6000	●
2.0 × 61 × 32	5000	●
1.2 × 65 × 18	5000	●
1.5 × 65 × 18	5000	●
1.5 × 70 × 25	5000	●
1.5 × 70 × 30	5000	●
2.0 × 70 × 25	5000	●
2.0 × 70 × 30	5000	●
1.5 × 75 × 25	5000	●
1.5 × 75 × 45	5000	●
1.5 × 75 × 45	6000	●
2.0 × 75 × 25	5000	●
2.0 × 75 × 45	5000	●
2.0 × 75 × 45	6000	●
3.0 × 75 × 45	5000	●
1.5 × 80 × 40	5000	●
1.5 × 80 × 40	6000	●
2.0 × 80 × 40	5000	●
2.0 × 80 × 40	6000	●
3.0 × 80 × 40	5000	●
1.5 × 90 × 30	5000	●
1.5 × 90 × 50	5000	●
1.5 × 90 × 30	6000	●
2.0 × 90 × 30	5000	●
2.0 × 90 × 50	5000	●
3.0 × 90 × 30	5000	●
3.0 × 90 × 50	5000	●

●寸法は全てmm単位です。

ステンレス材

材質：SUS304 HL 仕上げ

ステンレス 丸パイプ



t × A	長さ	HL
1.0 × 8	4000	●
1.0 × 10	4000	●
1.0 × 12	4000	●
1.0 × 13	4000	●
1.2 × 13	4000	●
1.5 × 13	4000	●
1.2 × 13.8	4000	●
1.5 × 13.8	4000	●
1.0 × 15	4000	●
0.8 × 16	4000	●
1.0 × 16	4000	●
1.2 × 16	4000	●
1.5 × 16	4000	●
2.0 × 16	4000	●
1.5 × 17.3	4000	●
2.0 × 17.3	4000	●
0.8 × 19	4000	●
1.0 × 19	4000	●
1.2 × 19	4000	●
1.5 × 19	4000	●
2.0 × 19	4000	●
1.0 × 21.7	4000	●
1.2 × 21.7	4000	●
1.5 × 21.7	4000	●
2.0 × 21.7	4000	●
3.0 × 21.7	4000	●
1.0 × 22.0	4000	●
1.2 × 22.0	4000	●
1.5 × 22.0	4000	●
2.0 × 22.0	4000	●
0.8 × 25.0	4000	●
1.0 × 25.0	4000	●
1.2 × 25.0	4000	●
1.5 × 25.0	4000	●
2.0 × 25.0	4000	●
3.0 × 25.0	4000	●
1.0 × 25.4	4000	●
1.2 × 25.4	4000	●
1.5 × 25.4	4000	●
2.0 × 25.4	4000	●
1.0 × 27.2	4000	●
1.2 × 27.2	4000	●
1.5 × 27.2	4000	●
2.0 × 27.2	4000	●
3.0 × 27.2	4000	●
1.0 × 32.0	4000	●
1.2 × 32.0	4000	●

t × A	長さ	HL
1.5 × 32.0	4000	●
2.0 × 32.0	4000	●
3.0 × 32.0	4000	●
1.0 × 34.0	4000	●
1.2 × 34.0	4000	●
1.5 × 34.0	4000	●
2.0 × 34.0	4000	●
3.0 × 34.0	4000	●
1.2 × 38.0	4000	●
1.5 × 38.0	4000	●
2.0 × 38.0	4000	●
3.0 × 38.0	4000	●
1.2 × 42.7	4000	●
1.5 × 42.7	4000	●
2.0 × 42.7	4000	●
3.0 × 42.7	4000	●
1.5 × 45.0	4000	●
2.0 × 45.0	4000	●
1.2 × 48.6	4000	●
1.5 × 48.6	4000	●
2.0 × 48.6	4000	●
3.0 × 48.6	4000	●
1.2 × 50.0	4000	●
1.5 × 50.0	4000	●
2.0 × 50.0	4000	●
3.0 × 50.0	4000	●
1.5 × 60.5	4000	●
2.0 × 60.5	4000	●
3.0 × 60.5	4000	●
1.5 × 76.3	4000	●
2.0 × 76.3	4000	●
3.0 × 76.3	4000	●
1.5 × 89.1	4000	●
2.0 × 89.1	4000	●
3.0 × 89.1	4000	●
1.5 × 101.6	4000	●
2.0 × 101.6	4000	●
3.0 × 101.6	4000	●
2.0 × 114.3	4000	●
3.0 × 114.3	4000	●
2.0 × 139.8	4000	●
3.0 × 139.8	4000	●
3.0 × 165.2	4000	●
4.0 × 165.2	4000	●

●寸法は全てmm単位です。

●寸法は全てmm単位です。

ステンレス フラットバー

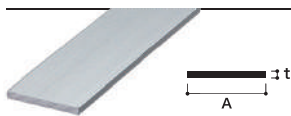

t × A	長さ	HL
2.0 × 10	4000	●
3.0 × 10	4000	●
4.0 × 10	4000	●
5.0 × 10	4000	●
4.0 × 11	4000	●
3.0 × 12	4000	●
5.0 × 12	4000	●
3.0 × 13	4000	●
4.0 × 13	4000	●
5.0 × 13	4000	●
2.0 × 15	4000	●
3.0 × 15	4000	●
4.0 × 15	4000	●
5.0 × 15	4000	●
3.0 × 16	4000	●
4.0 × 16	4000	●
5.0 × 16	4000	●
3.0 × 19	4000	●
4.0 × 19	4000	●
5.0 × 19	4000	●
2.0 × 20	4000	●
3.0 × 20	4000	●
4.0 × 20	4000	●
5.0 × 20	4000	●
3.0 × 22	4000	●
4.0 × 22	4000	●
5.0 × 22	4000	●
2.0 × 25	4000	●
3.0 × 25	4000	●
4.0 × 25	4000	●
5.0 × 25	4000	●
2.0 × 30	4000	●
3.0 × 30	4000	●
4.0 × 30	4000	●
5.0 × 30	4000	●
2.0 × 32	4000	●
3.0 × 32	4000	●
4.0 × 32	4000	●
5.0 × 32	4000	●
5.0 × 34	4000	●
3.0 × 35	4000	●
4.0 × 35	4000	●
5.0 × 35	4000	●
3.0 × 38	4000	●
4.0 × 38	4000	●
5.0 × 38	4000	●
2.0 × 40	4000	●

●寸法は全てmm単位です。

t × A	長さ	HL
3.0 × 40	4000	●
4.0 × 40	4000	●
5.0 × 40	4000	●
3.0 × 42	4000	●
3.0 × 45	4000	●
4.0 × 45	4000	●
2.0 × 50	4000	●
3.0 × 50	4000	●
4.0 × 50	4000	●
5.0 × 50	4000	●
2.0 × 55	4000	●
3.0 × 60	4000	●
4.0 × 60	4000	●
5.0 × 60	4000	●
3.0 × 65	4000	●
4.0 × 65	4000	●
5.0 × 65	4000	●
3.0 × 75	4000	●
4.0 × 75	4000	●
5.0 × 75	4000	●
5.0 × 90	4000	●
3.0 × 100	4000	●
4.0 × 100	4000	●
5.0 × 100	4000	●

ステンレス 等辺アングル

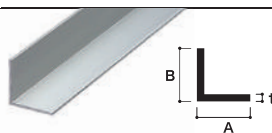

t × A × 幅	長さ	HL
3.0 × 20 × 20	4000	●
3.0 × 30 × 30	4000	●
3.0 × 40 × 40	4000	●
3.0 × 40 × 40	6000	●
4.0 × 40 × 40	4000	●
4.0 × 40 × 40	6000	●
5.0 × 40 × 40	4000	●
3.0 × 50 × 50	6000	●
4.0 × 50 × 50	4000	●
4.0 × 50 × 50	6000	●
5.0 × 50 × 50	4000	●

●寸法は全てmm単位です。

カーペット押え

アルミ

材質：A6063S-T5 定尺：L=4000 基本色：シルバー

A-2516

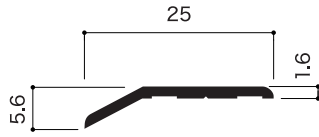

ブロンズ在庫あり

A-3515

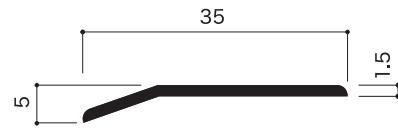

ブロンズ・ブラック・ホワイト在庫あり

A-5019

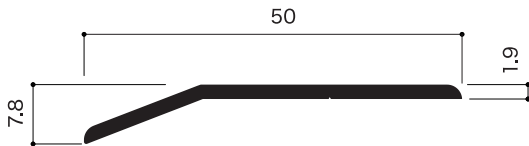

ブロンズ在庫あり

ステンレス

材質：SUS430 HL 仕上げ / (A)SUS304 HL 仕上げ 定尺：L=4000

S-2512

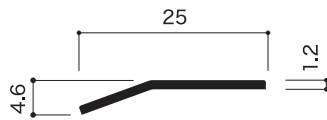

S-3815

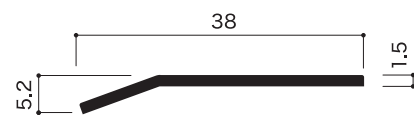

S-3512

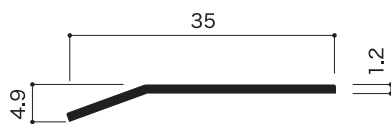

S-5015

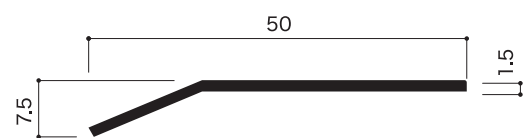

S-1015 (A)

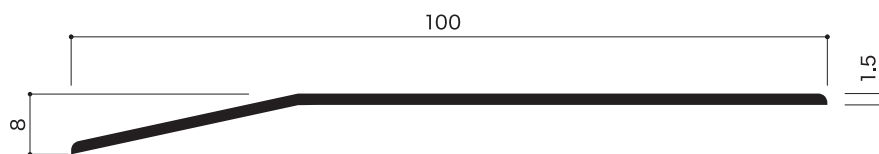

S-2625 (A)

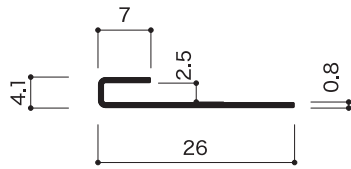

S-2510 (A)

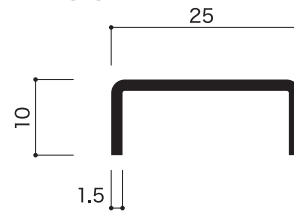

S-2654 (A)

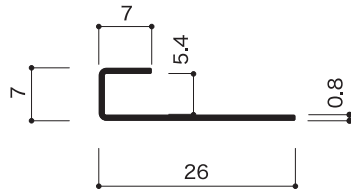

S-3010 (A)

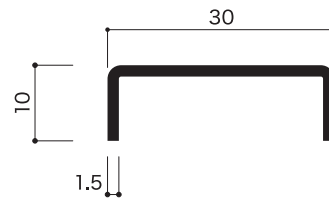

S-3594 (A)

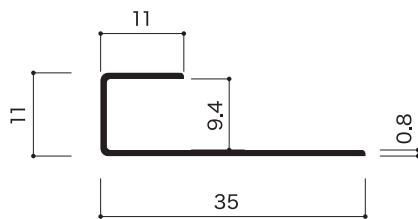

S-4020 (A)

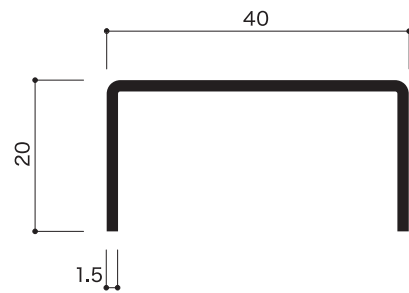

S-3865 (A)

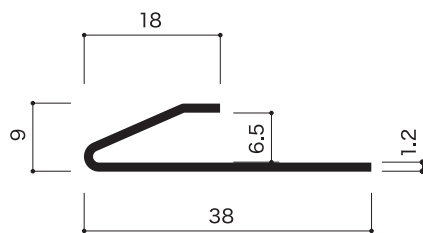

S-4495 (A)

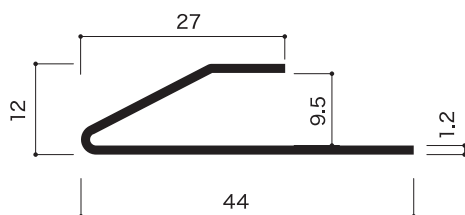

ノンスリップ

ゴムタイヤの色

No.1	No.2	No.3	No.4	No.5	No.6	No.7	No.8	No.9	No.10	No.11	No.12	No.13
ベージュ	グレー	ダーク グレー	ブラック	ソフト ブラウン	ダーク ブラウン	エンジ	レッド	リーフ グリーン	ブルー	ダーク ブルー	グリーン	イエロー

実際の色味と多少異なる場合がございます。

アルミ

材質：A60635-TS 定尺：L=4000 基本色：シルバー

A-38

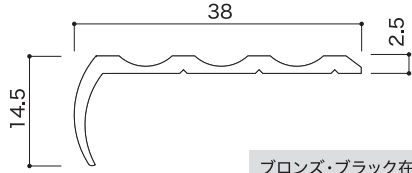

ブロンズ・ブラック在庫あり

A-140

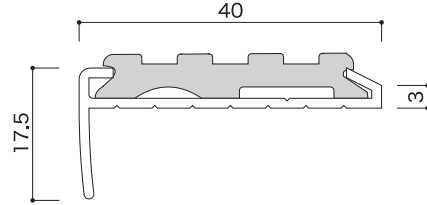

A-50

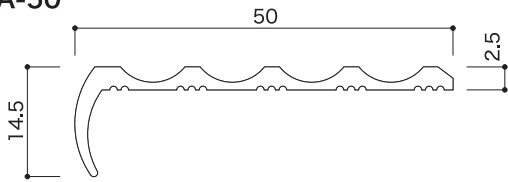

A-140J

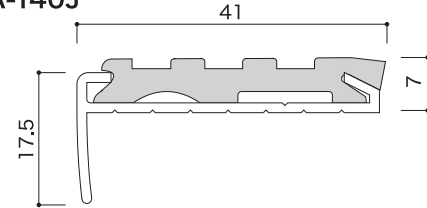

A-75

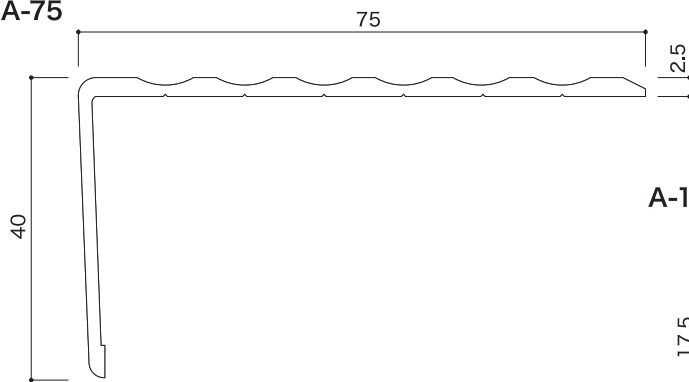

A-140K

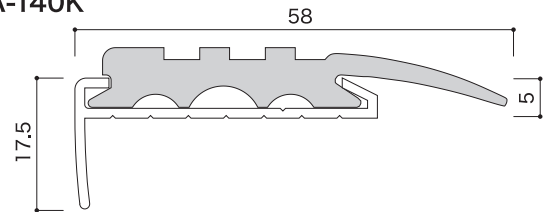

A-135

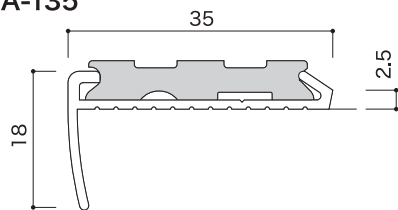

A-150

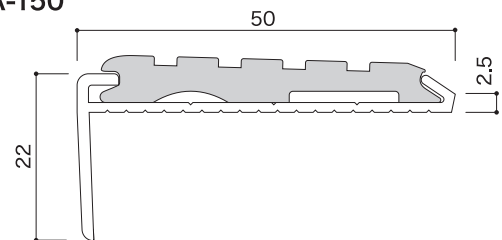

A-135J

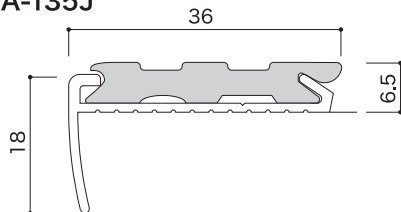

A-150L

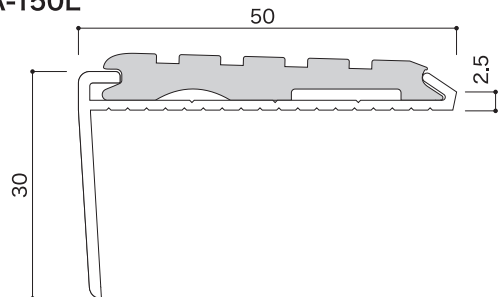

ノンスリップ

ゴムタイヤの色

No.1	No.2	No.3	No.4	No.5	No.6	No.7	No.8	No.9	No.10	No.11	No.12	No.13
ベージュ	グレー	ダーク グレー	ブラック	ソフト ブラウン	ダーク ブラウン	エンジ	レッド	リーフ グリーン	ブルー	ダーク ブルー	グリーン	イエロー

実際の色味と多少異なる場合がございます。

ステンレス

材質：SUS304 HL 仕上げ 定尺：L=4000

S-35

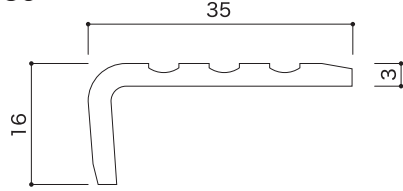

S-140

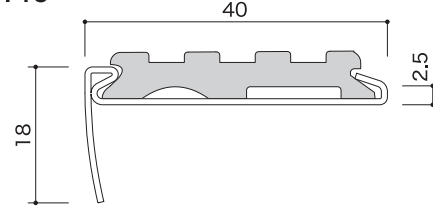

S-38S

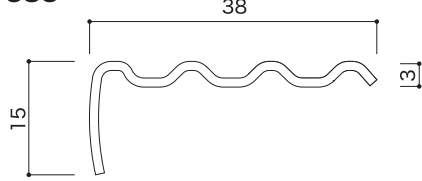

S-140J

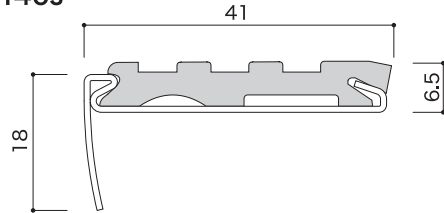

S-40

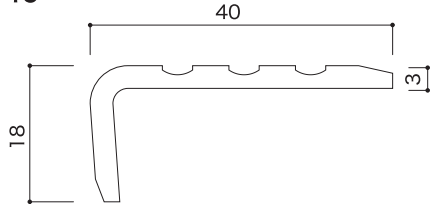

S-150

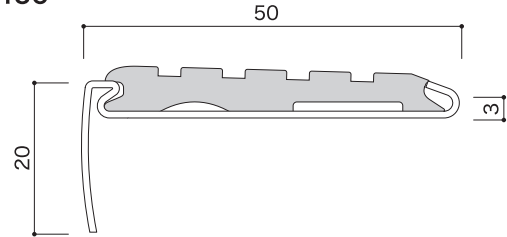

S-50

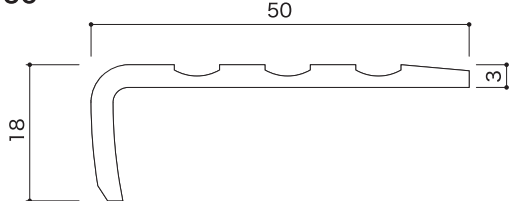

S-150L

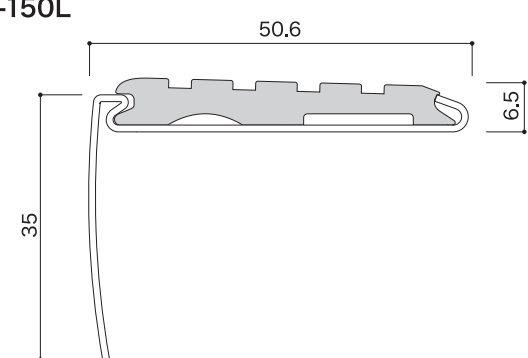

S-50S

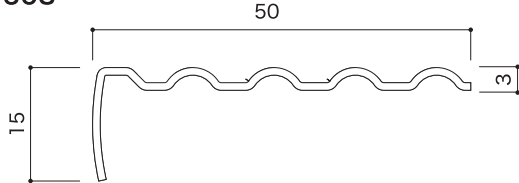

S-135

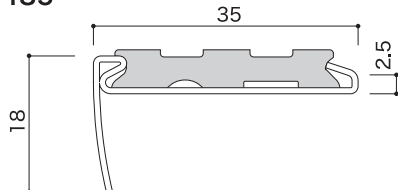

S-135J

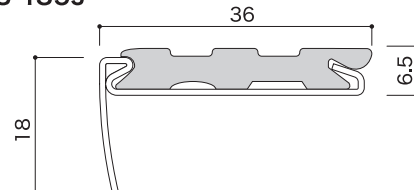



白水興産株式会社

本 社

〒105-0004 東京都港区新橋5-8-11 新橋エンタービル3F
TEL. (03)3431-9713(代) FAX. (03)3431-9708

関 東 支 店

〒340-0002 埼玉県草加市青柳6-16-1
TEL. (048)932-3853(代) FAX. (048)931-8164

埼玉物流センター

〒340-0002 埼玉県草加市青柳6-10-5
TEL. (048)931-8161(代) FAX. (048)931-8195

ホームページURL <http://www.hakusui-k.co.jp>